

## **CENOVNIK 2011**

**važi od  
01.08.2011. godine**

### **ACO Self program za individualnu gradnju**

*Lepa i jednostavna rešenja za vaš dom*

## ACO EuroSelf®

**Sistem za odvodnjavanje od polimer betona sa sistemom učvršćivanja rešetke bez vijaka**

- Za prelaz putničkih vozila
- Lagan kanal
- "V" presek
- CE oznaka

Svetla širina 10,0 cm	OPIS	Gr.duž. (cm)	Gr.šir. (cm)	Gr.vis. (cm)	Kom/pal.	Art. Br.	Cena EUR
<b>Kanal sa pokrivnom rešetkom</b>							
	1,0 m kanal sa rešetkom od pocinkovanog čelika	100,0	11,8	9,7	60	38700	<b>22,88</b>
	1,0 m kanal sa rešetkom od pocinkovanog čelika*	100,0	11,8	9,7	60	38701	<b>33,98</b>
	0,5 m kanal sa rešetkom od pocinkovanog čelika	50,0	11,8	9,7	12	38702	<b>17,58</b>
	1,0 m kanal sa rešetkom od livenog gvožđa	100,0	11,8	10,0	60	38705	<b>51,99</b>
	1,0 m kanal sa rešetkom od livenog gvožđa*	100,0	11,8	10,0	12	38706	<b>58,65</b>
	0,5 m kanal sa rešetkom od livenog gvožđa	50,0	11,8	10,0	12	38707	<b>29,51</b>
	1,0 m kanal sa rešetkom od nerđajućeg čelika	100,0	11,8	9,9	60	38710	<b>181,30</b>
	1,0 m kanal sa rešetkom od nerđajućeg čelika*	100,0	11,8	9,9	12	38711	<b>187,96</b>
	0,5 m kanal sa rešetkom od nerđajućeg čelika	50,0	11,8	9,9	12	38712	<b>118,59</b>

**Sabirno okno sa pokrivnom rešetkom**

sabirno okno EK 30 sa rešetkom od pocinkovanog čelika	50,0	11,8	30,0	12	38703	<b>72,34</b>
sabirno okno EK 30 sa rešetkom od livenog gvožđa	50,0	11,8	30,0	12	38708	<b>85,20</b>
sabirno okno EK 30 sa rešetkom od nerđajućeg čelika	50,0	11,8	30,0	12	38713	<b>178,67</b>

**Dodatni pribor**

čeonni poklopac za početak i kraj kanala	50	38504	<b>4,20</b>
čeonni poklopac sa priključkom na odvod DN 100	7	38505	<b>16,71</b>
sifon (crni) za sabirno okno EK 30 / DN 100	12	01684	<b>10,36</b>
sifon (beli) za kanal	25	01666	<b>3,76</b>
ceva za spoj na odvod DN 100	20	01554	<b>4,16</b>
kuka za podizanje rešetki	5	03429	<b>11,54</b>

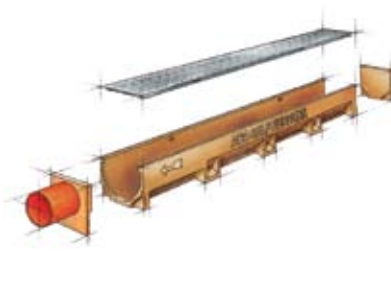
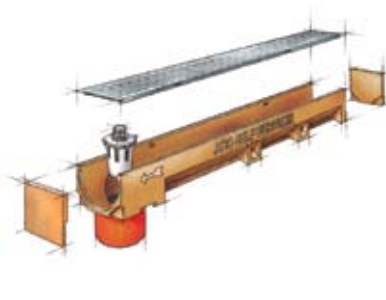
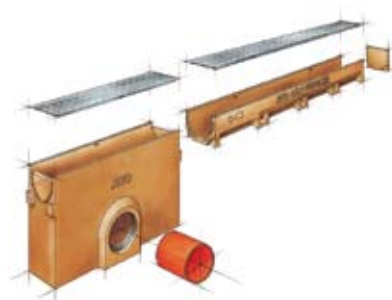









\* Kanal sa izrađenim vertikalnim izlivom DN 100

## ACO HexaSelf®

### Sistem za odvodnjavanje od plastike, sa plastičnom ili pocinkovanom rešetkom

- Za prelaz putničkih vozila
- CE oznaka

Svetla širina 10.0 cm	OPIS	Gr.duž. (cm)	Gr.šir. (cm)	Gr.vis. (cm)	Kom/pal.	Art. Br.	Cena EUR
<b>Kanal sa pokrivnom rešetkom</b>							
	1,0 m kanal od plastike crn kanal - crna plastična rešetka	100	12,5	7,6	72	19210	<b>13,12</b>
	1,0 m kanal od plastike sivi kanal - pocinkovana rešetka	100	12,5	7,6	72	19223	<b>18,11</b>
	1,0 m kanal od plastike crn kanal - crna plastična šlic rešetka	100	12,5	13,6	60	19555	<b>20,14</b>
<b>Dodatni pribor</b>							
	ugaoni element - crni				10	19280	<b>10,01</b>
	ugaoni element - sivi				10	19296	<b>10,84</b>
	ugaoni element - crni, za šlic kanal sa izlivom DN100				10	19560	<b>15,57</b>
	dodatni pribor - crni komplet *				60	19287	<b>6,02</b>
	dodatni pribor - sivi komplet *				60	19297	<b>6,19</b>

### GARAGE PACK HexaSelf \*

74771 54,07



\* dodatni pribor - komplet sadrži: 2 x čeonu poklopac, element za izliv, hvatač lišća

\* GARAGE PACK HexaSelf® - komplet sadrži: 3 m sivog kanala sa sivom plastičnom rešetkom i dodatni pribor sivi komplet

## ACO Vario®

## ACO Vario® - sistem otirača za cipele, ulošci otirača i kadice sa otvorom za izliv

OPIS	Gr.duž. (cm)	Gr.šir. (cm)	Gr.vis. (cm)	Art. Br.	Cena EUR	
<b>Vario kadica od polimer betona sa rubom od pocinkovanog čelika</b>						
	60 x 40 kadica za otirač	60,0	40,0	8,0	00398	<b>58,71</b>
	75 x 50 kadica za otirač	75,0	50,0	8,0	00399	<b>68,35</b>
	100 x 50 kadica za otirač	100,0	50,0	8,0	00400	<b>101,65</b>

## Dodatni pribor za kadice

cev za spoj na odvod DN100	10,0			01554	<b>4,16</b>
----------------------------	------	--	--	-------	-------------

## Vario Outdoor ulošci za kadice

	60 x 40 uložak - čelični pocinkovani, mrežasti	60,0	40,0	2,0	01207	<b>29,76</b>
	75 x 50 uložak - čelični pocinkovani, mrežasti	75,0	50,0	2,0	01208	<b>47,25</b>
	100 x 50 uložak - čelični pocinkovani, mrežasti	100,0	50,0	2,0	01209	<b>60,39</b>
	60 x 40 uložak - rips, antracit	60,0	40,0	2,0	01210	<b>66,31</b>
	75 x 50 uložak - rips, antracit	75,0	50,0	2,0	01211	<b>98,44</b>
	100 x 50 uložak - rips, antracit	100,0	50,0	2,0	01212	<b>136,36</b>
	60 x 40 uložak - rips, svetlo siva	60,0	40,0	2,0	02180	<b>70,75</b>
	75 x 50 uložak - rips, svetlosiva	75,0	50,0	2,0	02181	<b>106,62</b>
	100 x 50 uložak - rips, svetlo siva	100,0	50,0	2,0	02182	<b>154,18</b>
	60 x 40 uložak - guma, cm	60,0	40,0	2,0	01213	<b>85,22</b>
	75 x 50 uložak - guma, cm	75,0	50,0	2,0	01214	<b>134,95</b>
	100 x 50 uložak - guma, cm	100,0	50,0	2,0	01215	<b>174,87</b>

4

**Otirač "Indoor" za unutrašnjost sa aluminijumskim okvirom, ukupne visine 10 mm, za montažu u podnu oblogu**

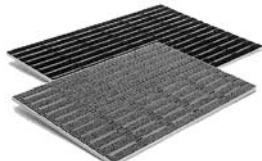
OPIS	Gr.duž. (cm)	Gr.šir. (cm)	Gr.vis. (cm)	Art. Br.	Cena EUR	
	60 x 40 rips antracit, sa okvirom	60,0	40,0	1,0	37250	<b>75,07</b>
	75 x 50 rips antracit, sa okvirom	75,0	50,0	1,0	37255	<b>108,76</b>
	60 x 40 rips siva, sa okvirom	60,0	40,0	1,0	37251	<b>75,07</b>
	75 x 50 rips siva, sa okvirom	75,0	50,0	1,0	37256	<b>108,76</b>

**Dvorišni slivnik od polimer betona za odvodnjavanje, sa rešetkom od pocinkovanog čelika ili livenog gvožđa, sa sifonom i PP koficom**
**Klase opterećenja od A15 do B125 po SRPS EN 1433**

OPIS	Gr.duž. (cm)	Gr.šir. (cm)	Gr.vis. (cm)	Art. Br.	Cena EUR
<b>Dvorišni slivnik</b>					
slivnik sa čeličnom pocinkovanom rebrastom rešetkom	25,0	25,0	35,0	01581	<b>69,76</b>
element za povećanje visine 20 cm	25,0	25,0	20,0	02102	<b>46,69</b>

**Dvorišni slivnik sa pocinkovanim zaštitnim rubom**

slivnik sa pocinkovanim rubom i čeličnom pocinkovanom mrežastom rešetkom	25,0	25,0	35,2	36889	<b>121,76</b>
slivnik sa pocinkovanim rubom i liveno gvozdenom rešetkom	25,0	25,0	36,2	36890	<b>114,75</b>
element za povećanje visine 20 cm	25,0	25,0	20,0	02102	<b>46,69</b>

**ACO Drain - dvorišni slivnik od polimer betona za odvodnjavanje, sa liveno gvozdenim rubom, rešetkom od pocinkovanog čelika ili livenog gvožđa, sifonom i PP kanticom, izlivom DN 100, klase opterećenja do B125 kN**

OPIS	Gr.duž. (cm)	Gr.šir. (cm)	Gr.vis. (cm)	Art. Br.	Cena EUR
<b>Dvorišni slivnik sa liveno gvozdenim rubom</b>					
slivnik sa liveno gvozdenim rubom i liveno gvozdenom rešetkom	30,0	30,0	44,0	10500	<b>191,37</b>
slivnik sa livenom gvozdenom rubom i čeličnom pocinkovanom rešetkom	30,0	30,0	44,0	10501	<b>225,76</b>
element za povećanje visine 6 cm	28,5	28,5	6,0	02717	<b>23,32</b>
element za povećanje visine 25 cm	28,5	28,5	25,0	02716	<b>41,00</b>



**ACO Areal®**

**ACO Areal® travna rešetka**

OPIS	Gr.duž. (cm)	Gr.šir. (cm)	Gr.vis. (cm)	Art. Br.	Cena EUR
<b>Travna rešetka</b>					
 58 x 39 x 3,8 travna rešetka U 1 m <sup>2</sup> ide 4,41 komad rešetki	58,0	39,0	3,8	81070	<b>4,98</b>

**Dodatni pribor**



marker za parkirno mesto beli (10 kom)	81072	<b>9,67</b>
18 x Ø 0,6 ekser za učvršćivanje rešetki (50 kom)	81073	<b>9,71</b>



## ACO TopTek® revizioni poklopci za pešačko opterećenje od aluminijuma

### ACO TopTek® UNIFACE AL Upušteni revizioni poklopci

Revizioni poklopci se proizvode od legure aluminijuma i magnezijuma. Snebdeveni su zaptivkama i pričvršćeni vijcima. Jedinstveni nezavareni oblik

rama i poklopca omogućava laku ugradnju. Dvostruko zaptivanje kao i dodatna zaptivka su standardni. Težina je smanjena na minimum, ali obezbeđuje

iste mehaničke karakteristike kao i standardni aluminijumski poklopac.

Tip Svetli otvor (mm)	C x D (mm)	Nosivost (kN) 50 mm betonske ispune	Nosivost (kN) 70 mm betonske ispune	Masa (kg)	Art. br.	Cena (EUR)
200 x 200	298 x 298	125	125	3	406881	136,03
300 x 300	398 x 398	100	125	4	405340	158,32
400 x 400	498 x 498	100	125	5	405341	184,23
450 x 450	548 x 548	50	125	6	405342	195,14
500 x 500	598 x 598	50	125	7	405343	212,15
600 x 400	698 x 498	50	125	7	405344	211,76
600 x 450	698 x 548	50	125	7	406622	221,48
600 x 600	698 x 698	50	125	8	405345	244,96
675 x 675	773 x 773	15	50	10	406624	273,30
750 x 600	848 x 698	50	125	10	406623	276,92
750 x 750	848 x 848	15	50	11	406625	292,31
800 x 600	898 x 698	50	125	10	405346	280,97
1000 x 600	1098 x 698	50	125	12	405826	308,50
700 x 700	798 x 798	15	100	10	405347	277,35
800 x 800	898 x 898	15	100	12	405348	308,12
900 x 600	998 x 698	50	125	11	406626	291,92
900 x 900	998 x 998	15	50	14	406627	344,13
1000 x 800	1098 x 898	15	50	13	405349	353,46
1000 x 1000	1098 x 1098	15	50	16	405350	388,66
1200 x 675*	1318 x 773	15	50	23	406628	655,87

\*poklopac iz dva dela sa uklonjivom oslonačkom gredom

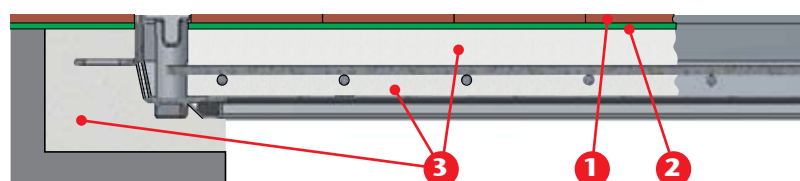
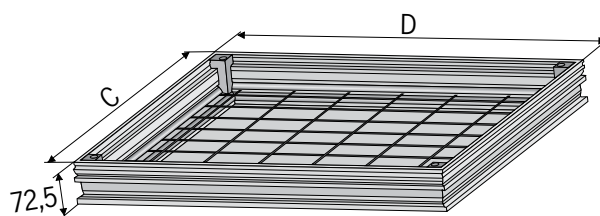

- 1** završni sloj (npr. keramičke pločice)
- 2** vezivni sloj
- 3** betonska ispuna - MB 45

**ACO**  
**niskogradnja**



**ACO**  
**visokogradnja**



**ACO**  
**samogradnja**



**ACO**  
**tehnika za objekte**

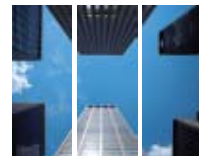

**ACO. Budućnost u odvodnjavanju.**



**ACO**  
**gradjevinski elementi d.o.o.**

Mala pruga 39a  
11283 Beograd 135  
Srbija

Tel: +381 11 377 77 91

Tel: +381 11 375 08 57

Fax: +381 11 375 76 18

E-mail: [aco@aco.rs](mailto:aco@aco.rs)

**[www.aco.rs](http://www.aco.rs)**

Zadržavamo pravo izmena

ACO-07/11