

**PRO**

Shower tray, made of Marbond composite material, super flat, square, outlet at side

**DIMENSIONS**

Length	900 mm
Width	900 mm
Height	30 mm

**COLOUR AND FINISH**

000 White

**OPTIONS**

000 - standard option



**SPECIFICATION TEXT**

Square shower tray made of Marbond (Gel Coat surface matt, with structure) with Antislip, Class C (DIN 51097) Removable siphon cover, stainless steel For floor-even installation or on floor installation

**MOUNTING ACCESSORIES EXCLUDED**

Mounting box type DN 50, height 100 mm incl. waste, Ø 90 mm without cover (pre-assembled) left, order no. 29004.3, right, order no. 29004.4  
 Mounting box type DN 40, height 75 mm incl. waste, Ø 90 mm without cover (pre-assembled) left, order no. 29003.3, right, order no. 29003.4  
 Waste DN 50, Ø 90 mm without cover, order no. 29512.7 Mounting box type DN 50, height 100 mm, left, order no. 29004.1, right, order no. 29004.2  
 Mounting box type DN 40, height 75 mm, left, order no. 29003.1, right, order no. 29003.2  
 Installation frame, adjustable height between 85-160 mm, order no. 29844.1 Antinoise set for the frame installation to fulfil DIN 4109 and SIA 181, order no. 29898.8 3-D sealing tape: Sealing set 3,0 m, for sealed sides ) 3 m, includes 1 sealing tape (width 120 mm, length 3 m), 3-D inside corner for sealing (1 piece) and 2x 3 m antinoise tape (width 30 mm), order no. 29564.2 Additional sealing set 2,0 m, for sealed sides \* 3 m, order no. 29564.7 3-D sealing corners: Inside corner, 1 piece, order no. 29564.3 Outside corner for floor-even installation, set 3 parts, order no. 29564.4 Dispersion sealing composition, tube 500 ml, order no. 29564.5 Noise control band, order no. 29555.1

Depth : Superslim (less than 45mm)

Net weight (kg) : 39.78

Waste diameter (mm) : 90

Installation type : Built-in, Corner

Shape : Square

Material : Marbond

Slip-resistant base (anti-slip)

TECHNICAL DRAWINGS

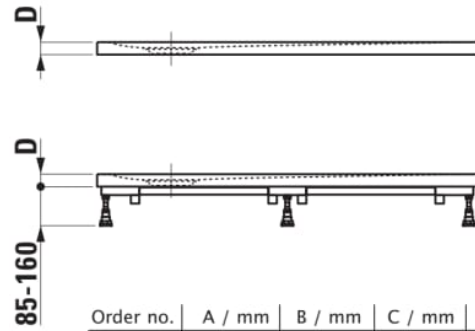
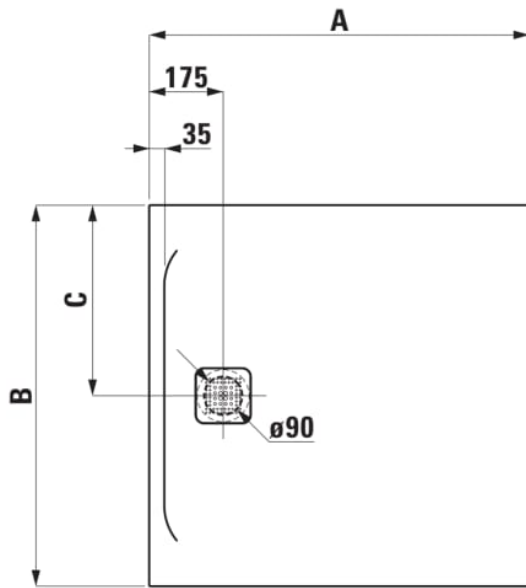

Order no.	A / mm	B / mm	C / mm	D / mm
21095.0	800	800	400	29
21095.6	900	900	450	30
21195.2	1000	1000	500	33
21195.8	1200	1200	600	33

COMPATIBLE WITH



Siphon cover for Pro shower trays Marbond

**H291950...0001**



Siphon cover for Pro shower trays Marbond, white matt, lines

**H291951...0001**



Siphon cover for Pro shower trays Marbond, white matt, discontinuous lines

**H291952...0001**



Installation frame for Marbond shower trays

**H295710...0001**



Installation frame for Marbond shower tray

**H2957250000001**



Drain DN 50, diameter 90 mm, without drain cover

**H295127...0001**



Noise control tape 1 roll = 3,30m

**H2955510000001**

3D inside corner with insulation for sealing

**H2956430000001**



3D multifunctional outside corner for walk-in installation

**H295644...0001**

Dispersion adhesive for sealing tape or 3D corner

**H2956450000001**

Sealing tape 2m

**H2956470000001**



Anti noise set for Laufen Solutions Marbond up to and including 120 cm for the frame installation to fulfill SIA181 and DIN4109

**H2989880000001**

## PRO

LAUFEN PRO is an exceptionally comprehensive collection, offering washbasins, faucets, WCs, shower trays and bathtubs in a wide range of sizes. Rooted in modern industrial design, it unites form, function and affordability, making it a versatile solution for every scale of project, from compact apartments to large developments and public spaces, delivering lasting value for architects, designers and homeowners alike.



#material\_text

MARBOND

## Marbond

Marbond is a composite material made of two layers which are extremely well connected with each other: The basis is formed by a high-quality mineral casting material, the surface is coated with a two millimetre thick acrylic layer. Marbond is hygienic, easy to clean, temperature resistant according to EN 263 and anti-slip (class C).